



NEMA Premium

NEMA

MOTOR MODEL:	GR3-CI-OP-444T-4-RR-E-125
FACTORY TYPE:	-

NEMA Cast Iron, ODP

ELECTRICAL DATA		
	60 Hz	50 Hz
Horsepower	125.0	-
Speed, RPM	1780	1480
Voltage	460	380
# Phase	3	
Full Load Amps	140.2	-
Power Factor	0.88	-
Nominal Efficiency	95.4	-
3/4 Load Efficiency	-	-
Service Factor	1.15	1.0
KVA Code	F	D
FL Amps. @ 208 V	-	-
LRC @ 60Hz HV	-	-
Start Capacitor	-	
Start Capacitor V	-	
Run Capacitor	-	
Run Capacitor V	-	
Number of Leads	6	
Connection	4D	
Coil Resistance	-	
Date Code	-	
Load	Efficiency %	P.F.
50%	94.21	0.8051
75%	95.1	0.8788
100%	95.4	0.88
FULL LOAD TEMPERATURE RISE		
FL Temp Rise °C	-	-
3D Image Link		
GR3-CI-OP-444T-4-RR-E-125		

GENERAL DATA		
Frame Size	444T	
Frame Enclosure	ODP	
Mounting	Rigid	
Insulation Class	F	
Duty	Cont. / S1	
NEMA Design	-	
Frame Material	Cast Iron	
Ingress Protection	23	
Tropicalization	true	
Cable Entry	-	
Feet Removable	-	
Double Drilled	-	
Paint Color	Graphite Gray	
Paint RAL	7024	
Weight lb	1949.88	
MECHANICAL DATA		
DE Bearing	NU319	
NDE Bearing	6316C3	
dB No-Load	-	
Rotor Wk ² , Lb-Ft ²	-	
Comp Ring (wavey washer)	-	
TORQUE VALUES	Torque lb-ft	% FLT
Locked Rotor Torque	-	-
Pull-Up Torque	-	-
Breakdown Torque	-	-
Full Load Torque	-	-
SITE CONDITIONS		
Ambient Temp °C	-	
Altitude Above Sea Level m	-	

*This report valid for above Date Code and newer models, please contact Techtop for more info.



NEMA Premium

NEMA

MOTOR MODEL:	GR3-CI-OP-444T-4-RR-E-125
FACTORY TYPE:	-

NEMA Cast Iron, ODP

Torque Speed (T-n) Curve

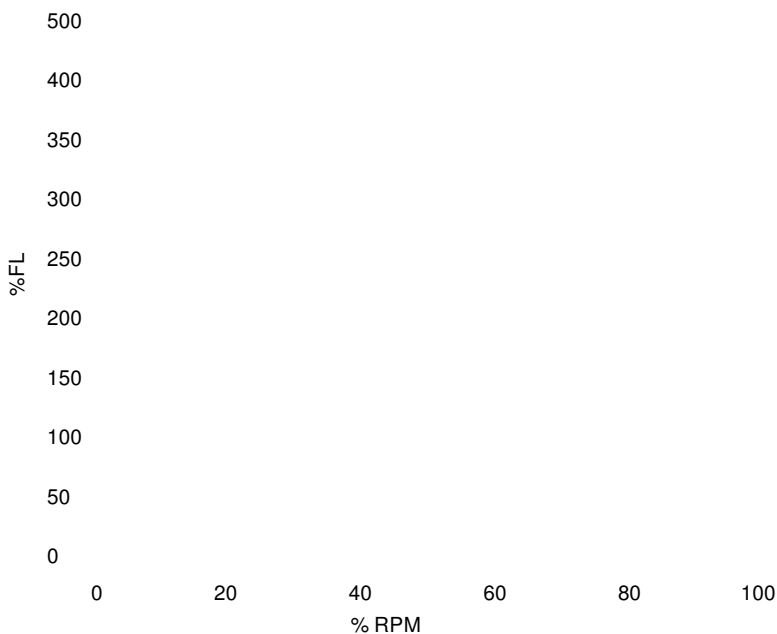

Performance Load Values, High Voltage, 60Hz

Torque Values	Torque lb-ft	% FLT	Performance Values
Locked Rotor Torque	-	-	Start Configuration
Pull-Up Torque	-	-	Starting Current (A)
Breakdown Torque	-	-	No-Load Current (A)
Full Load	-	-	No-Load Power Factor

% Load	Horsepower	Current, Amps	Input power, Kilowatts	Speed, RPM	Efficiency	PF
0	-	-	-	-	-	-
25	-	-	-	-	-	-
50	-	-	-	-	94.21	0.8051
75	-	-	-	-	95.1	0.8788
100	-	-	-	-	95.4	0.88
125	-	-	-	-	-	-