





IE3

IEC

<b>MOTOR MODEL:</b>	GR3-AL-TF-90SB35-2-B-D-2
<b>FACTORY TYPE:</b>	TAX

IE3 IEC Cast Aluminum, TEFC

Non Sinusoidal (VFD) Output 2.0HP, 3500 RPM

Torque Speed (T-n) Curve

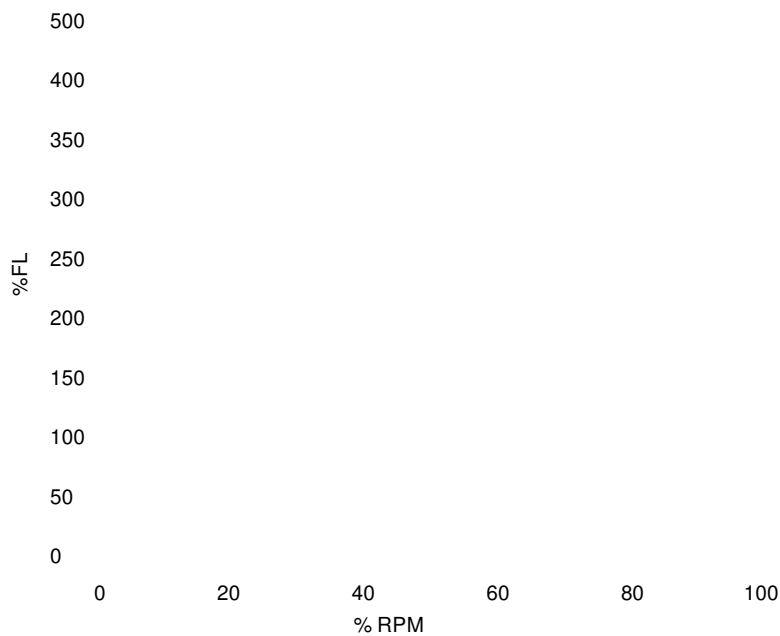

Performance Load Values, High Voltage, 60Hz

Torque Values	Torque lb-ft	% FLT	Performance Values
Locked Rotor Torque	-	-	Start Configuration
Pull-Up Torque	-	-	Starting Current (A)
Breakdown Torque	-	-	No-Load Current (A)
Full Load	-	-	No-Load Power Factor

% Load	Horsepower	Current, Amps	Input power, Kilowatts	Speed, RPM	Efficiency	PF
0	-	-	-	-	-	-
25	-	-	-	-	-	-
50	-	-	-	-	-	-
75	-	-	-	-	-	-
100	-	-	-	-	-	-
125	-	-	-	-	-	-