



NEMA Premium

NEMA

MOTOR MODEL:	BR3-CI-TF-364TC-4-BR-E-60
FACTORY TYPE:	TXC

Premium NEMA Cast Iron, TEFC

Torque Speed (T-n) Curve

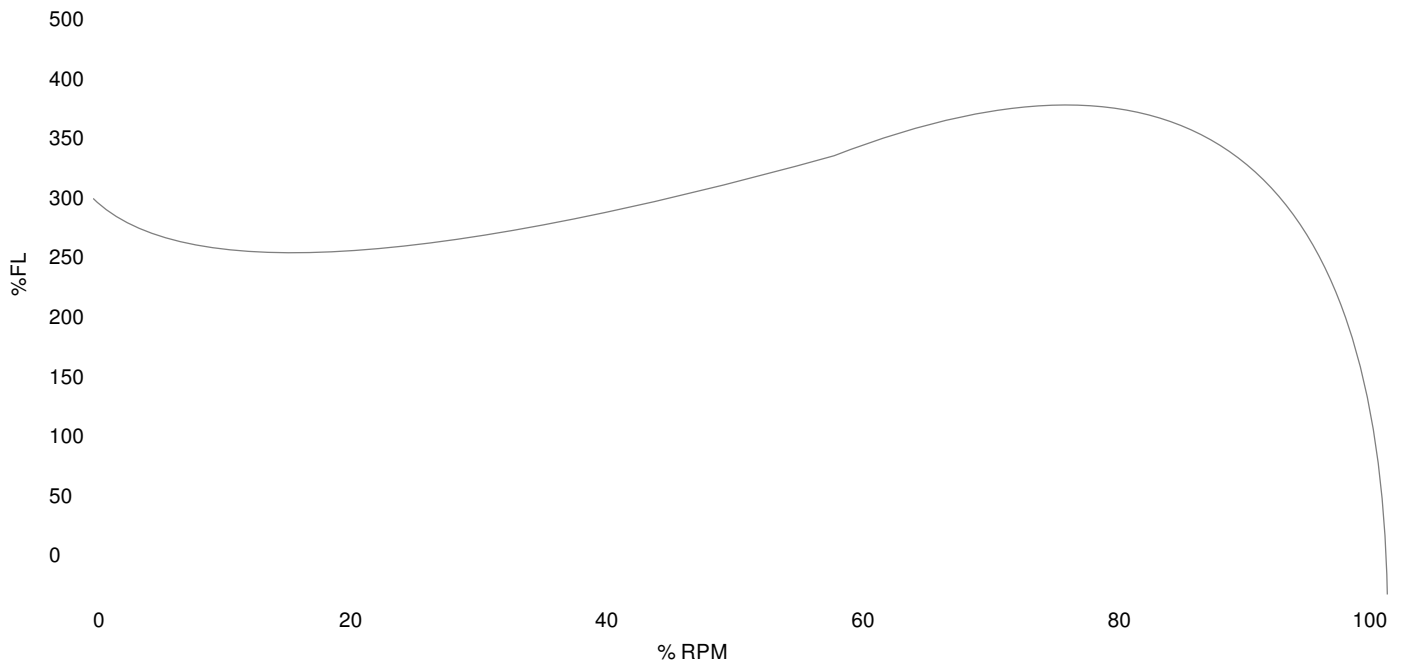

Performance Load Values, High Voltage, 60Hz

Torque Values	Torque lb-ft	% FLT	Performance Values	
Locked Rotor Torque	542.343	306.0	Start Configuration	-
Pull-Up Torque	368.651	208.0	Starting Current (A)	-
Breakdown Torque	600.831	339.0	No-Load Current (A)	-
Full Load	177.236	100.0	No-Load Power Factor	-

% Load	Horsepower	Current, Amps	Input power, Kilowatts	Speed, RPM	Efficiency	PF
0	-	22.39	-	-	-	-
25	15.0	27.61	12.34	1796.1	91.2	0.56
50	30.0	38.98	23.86	1792.3	94.31	0.77
75	45.0	52.43	35.57	1788.2	94.89	0.85
100	60.0	67.55	47.48	1783.9	94.77	0.88
125	75.0	83.89	59.63	1779.4	94.34	0.89

Techtop Industries
 2815 Colonnades Court
 Peachtree Corners, GA 30071
 Tel: 678-436-5540
 E-Mail: info@techttopind.com