





NEMA Premium

**NEMA**

<b>MOTOR MODEL:</b>	BR3-CI-TF-364T-6-BR-E-40
<b>FACTORY TYPE:</b>	TXC

Premium NEMA Cast Iron, TEFC

Torque Speed (T-n) Curve

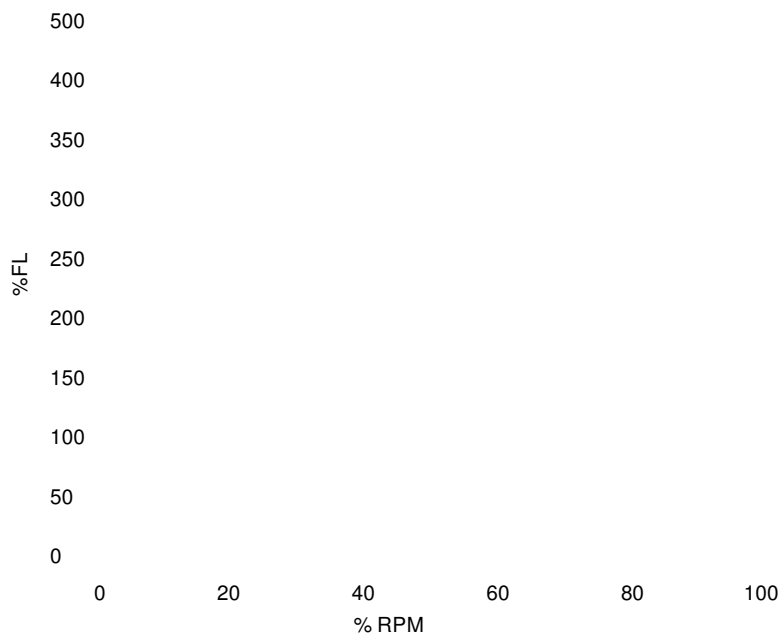

Performance Load Values, High Voltage, 60Hz

Torque Values	Torque lb-ft	% FLT	Performance Values
Locked Rotor Torque	-	-	Start Configuration
Pull-Up Torque	-	-	Starting Current (A)
Breakdown Torque	-	-	No-Load Current (A)
Full Load	-	100.0	No-Load Power Factor

% Load	Horsepower	Current, Amps	Input power, Kilowatts	Speed, RPM	Efficiency	PF
0	-	16.39	-	-	-	-
25	10.0	-	-	-	-	-
50	20.0	-	-	-	-	-
75	30.0	-	-	-	-	-
100	40.0	-	-	-	-	-
125	50.0	-	-	-	-	-