



IE1

IEC

MOTOR MODEL:	BL3-AL-TF-63B34-4-B-D-.35
FACTORY TYPE:	TM

IE1 IEC Cast Aluminum, TEFC

ELECTRICAL DATA		
	60 Hz	50 Hz
Horsepower	0.35	0.35
Speed, RPM	1650	1310
Voltage	230/460	190/380
# Phase	3	
Full Load Amps	1.56/0.78	1.84/0.92
Power Factor	0.6	-
Nominal Efficiency	66.1	-
3/4 Load Efficiency	-	-
Service Factor	1.15	1.0
KVA Code	J	F
FL Amps. @ 208 V	1.57	-
LRC @ 60Hz HV	-	-
Start Capacitor	-	
Start Capacitor V	-	
Run Capacitor	-	
Run Capacitor V	-	
Number of Leads	9	
Connection	YY/Y	
Coil Resistance	-	
Date Code	-	
Load	Efficiency %	P.F.
50%	-	-
75%	-	-
100%	-	-
FULL LOAD TEMPERATURE RISE		
FL Temp Rise °C	-	-
3D Image Link		
Not available for this motor		

GENERAL DATA		
Frame Size	63B34	
Frame Enclosure	TEFC	
Mounting	B34	
Insulation Class	F	
Duty	Cont. / S1	
NEMA Design	-	
Frame Material	Cast Aluminum	
Ingress Protection	55	
Tropicalization	true	
Cable Entry	1-M16X1.5	
Feet Removable	true	
Double Drilled	-	
Paint Color	Graphite Gray	
Paint RAL	7024	
Weight lb	11.0	
MECHANICAL DATA		
DE Bearing	6201ZZ	
NDE Bearing	6201ZZ	
dB No-Load	-	
Rotor Wk ² , Lb-Ft ²	-	
Comp Ring (wavy washer)	-	
TORQUE VALUES	Torque lb-ft	% FLT
Locked Rotor Torque	-	-
Pull-Up Torque	-	-
Breakdown Torque	-	-
Full Load Torque	-	-
SITE CONDITIONS		
Ambient Temp °C	40	
Altitude Above Sea Level m	1000	

*This report valid for above Date Code and newer models, please contact Techtop for more info.



IE1

IEC

MOTOR MODEL:	BL3-AL-TF-63B34-4-B-D-.35
FACTORY TYPE:	TM

IE1 IEC Cast Aluminum, TEFC

Torque Speed (T-n) Curve

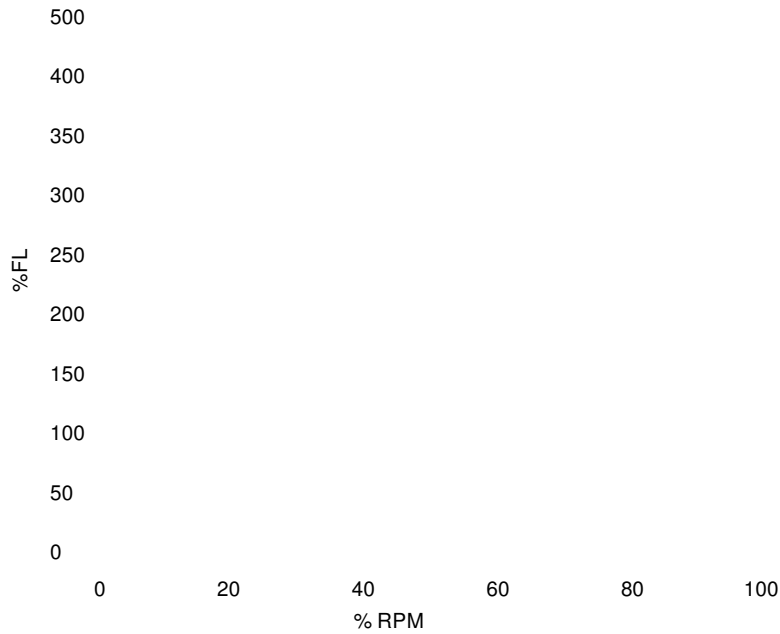

Performance Load Values, High Voltage, 60Hz

Torque Values	Torque lb-ft	% FLT	Performance Values
Locked Rotor Torque	-	-	Start Configuration
Pull-Up Torque	-	-	Starting Current (A)
Breakdown Torque	-	-	No-Load Current (A)
Full Load	-	-	No-Load Power Factor

% Load	Horsepower	Current, Amps	Input power, Kilowatts	Speed, RPM	Efficiency	PF
0	-	-	-	-	-	-
25	-	-	-	-	-	-
50	-	-	-	-	-	-
75	-	-	-	-	-	-
100	-	-	-	-	-	-
125	-	-	-	-	-	-